

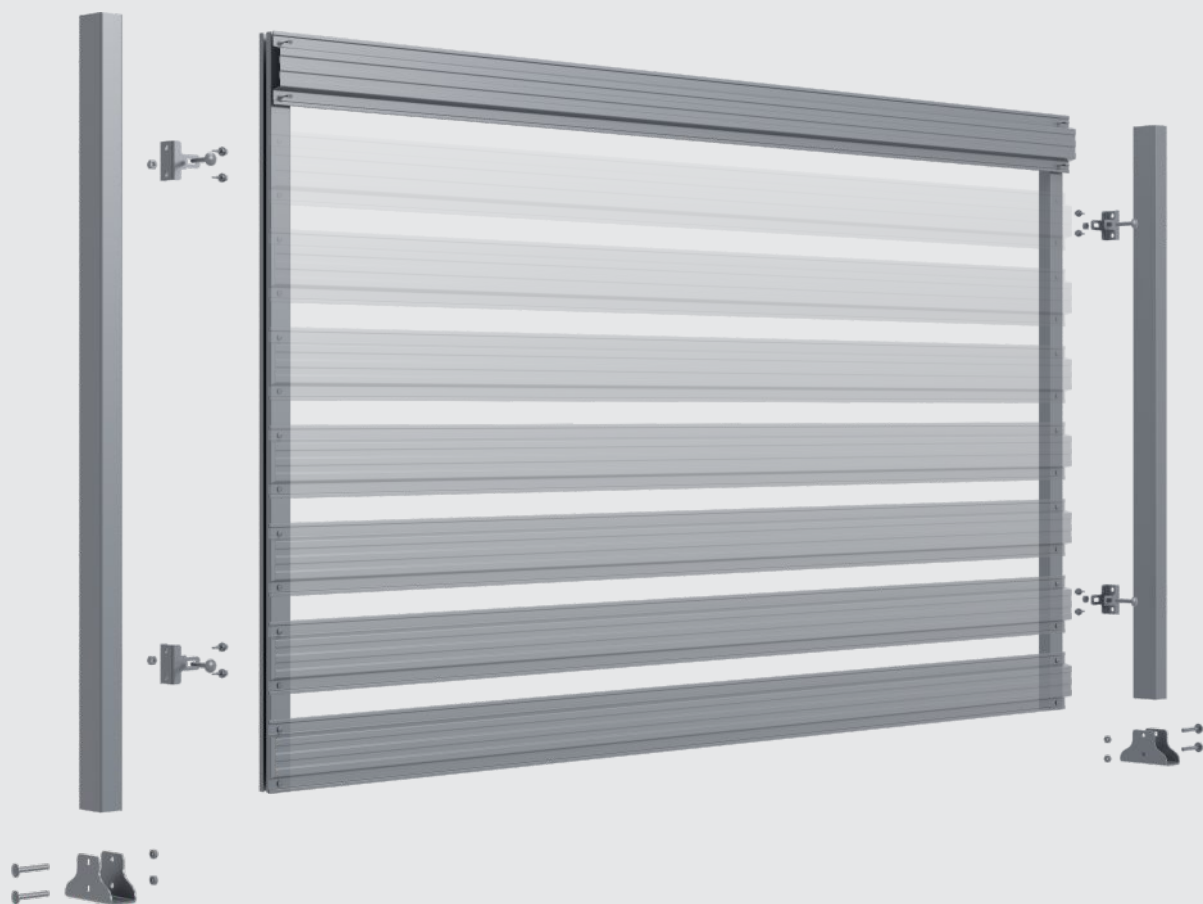







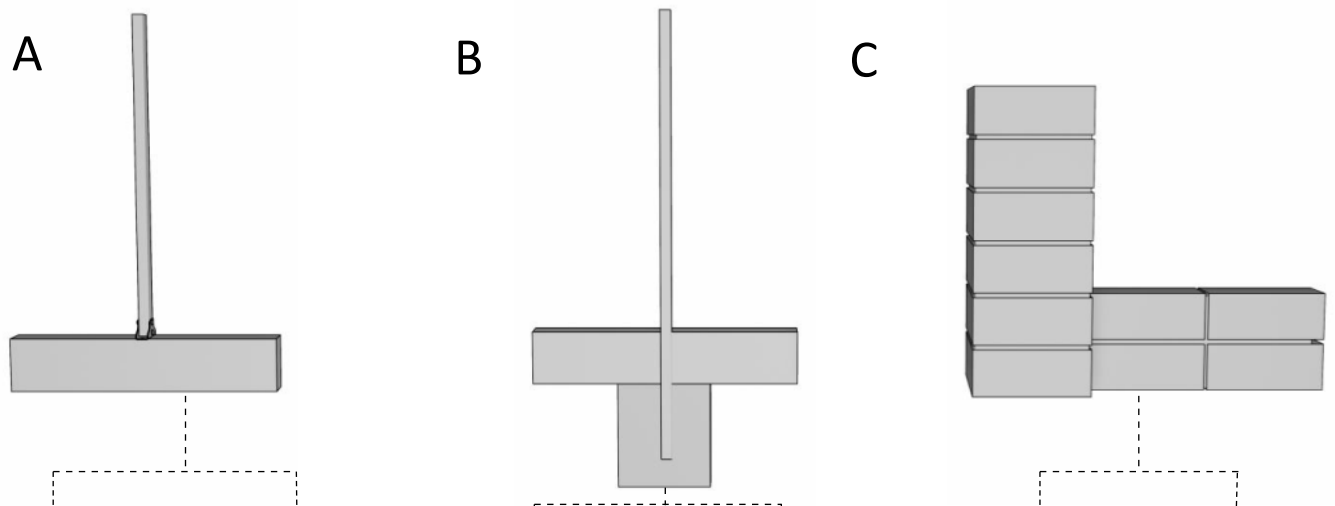
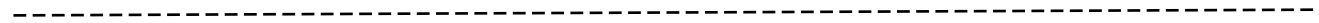
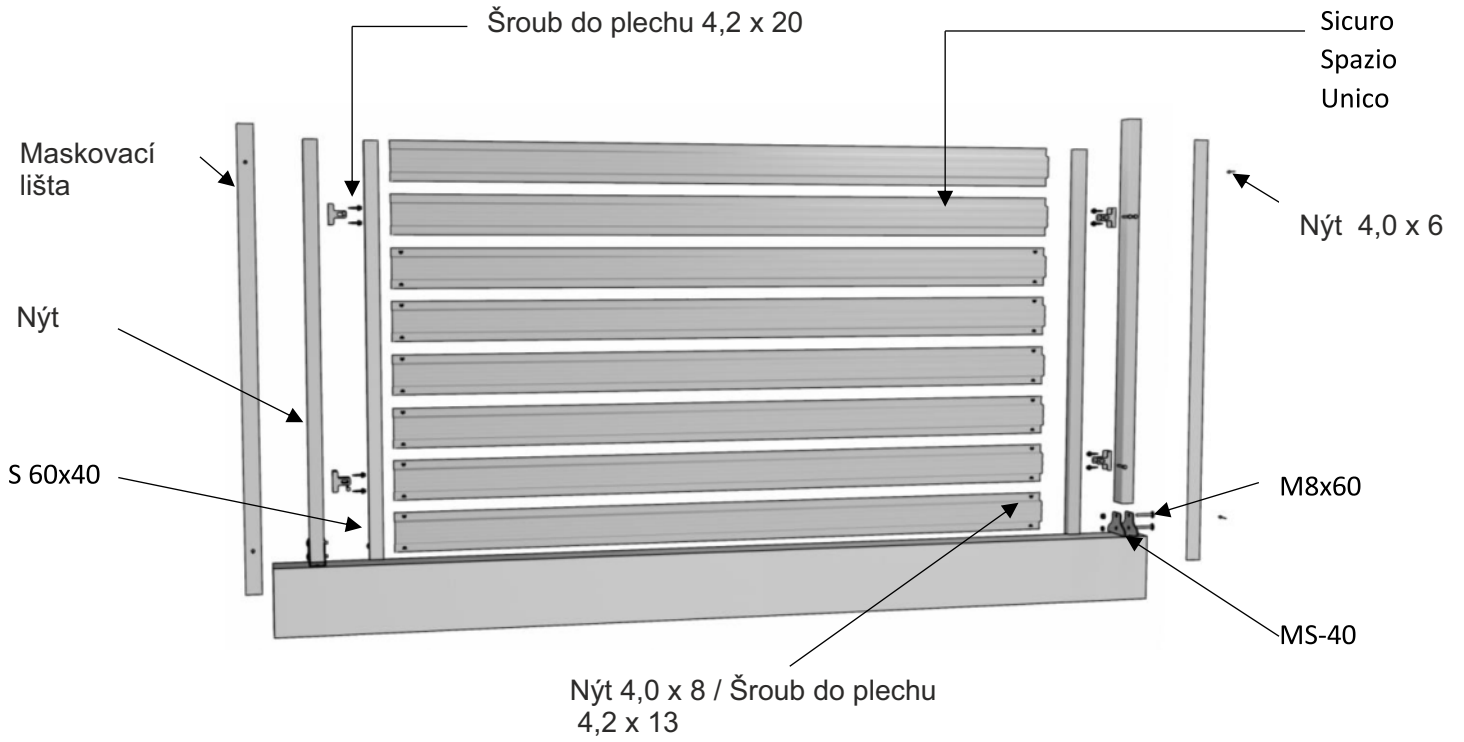

Budmat.

SYSTEM OPLOCENÍ



NÁVOD K MONTÁŽI VODOROVNÉ PŘÍČLE



 MZ-H	 4,2x20	 MZ-H	 4,2x20 M8x45	 MZ-H	 M8x45
 MS-40	 M8x60				

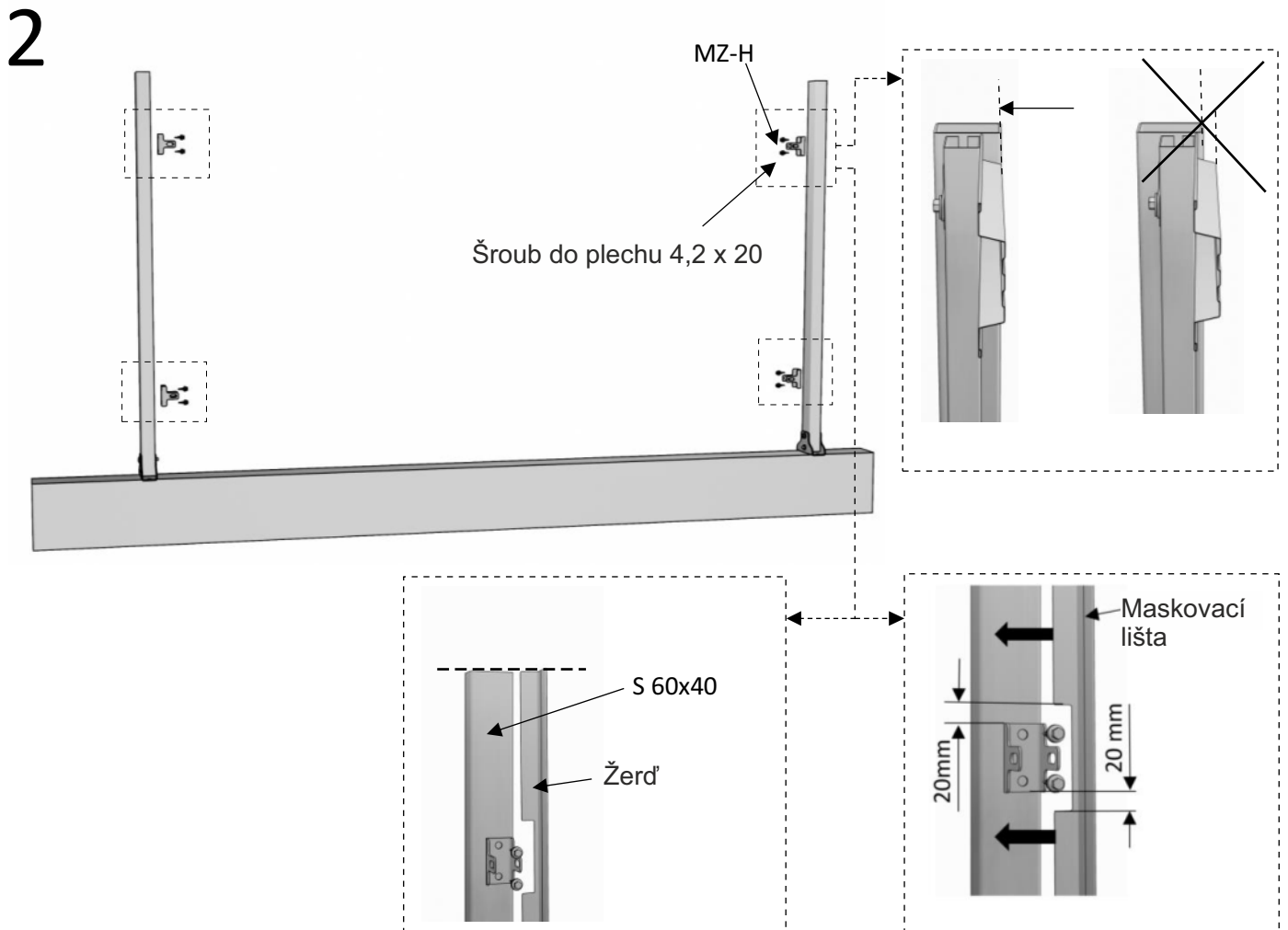
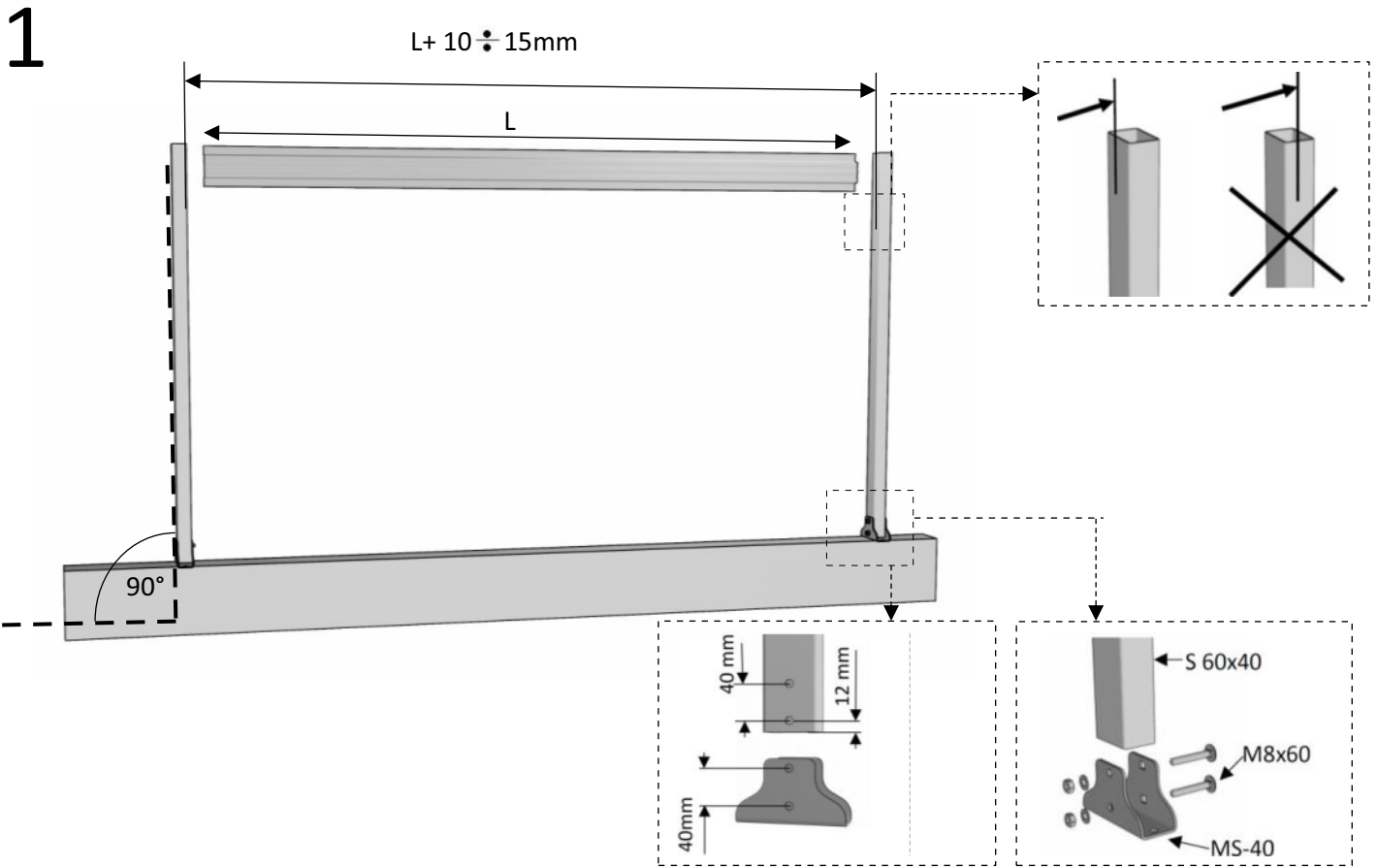

3

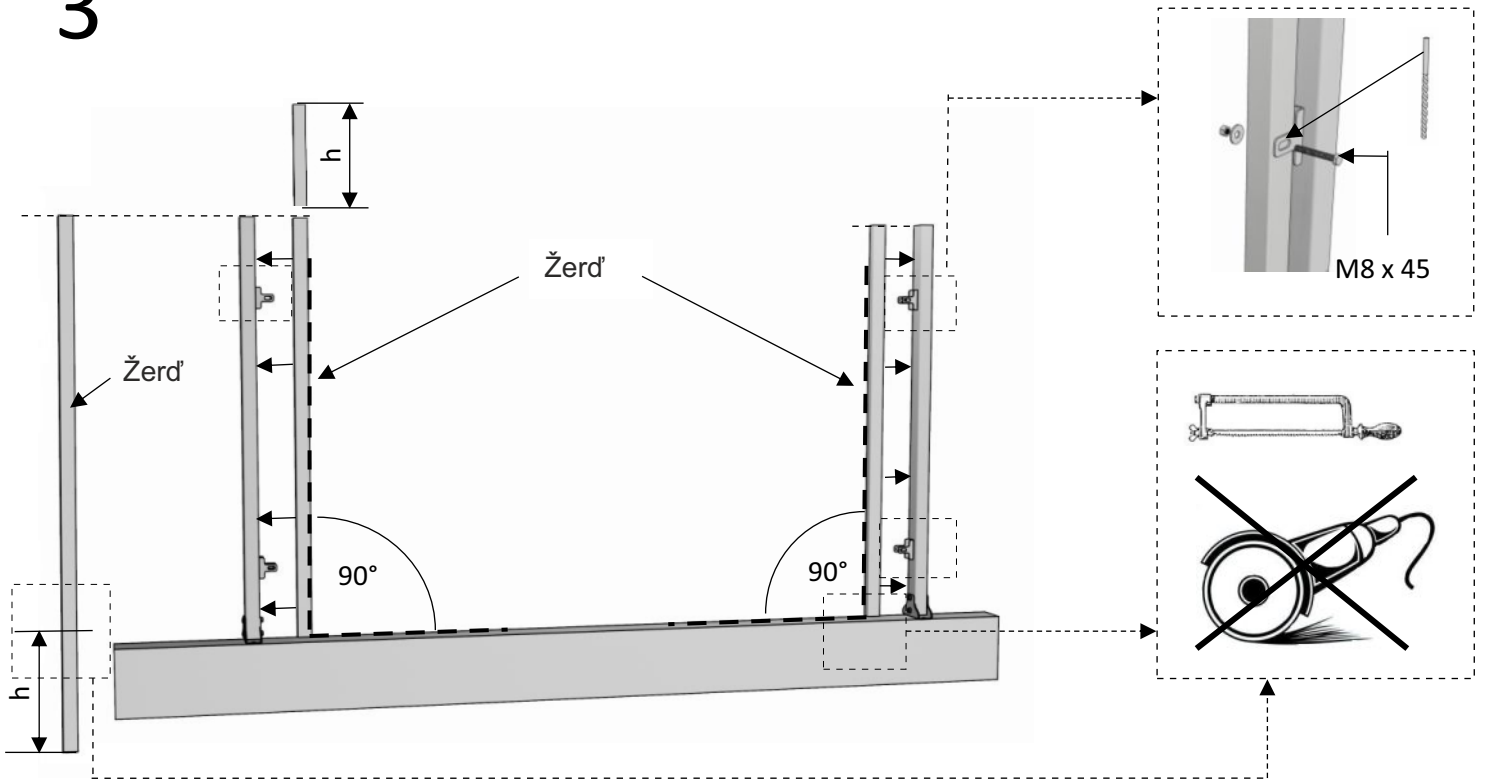

4

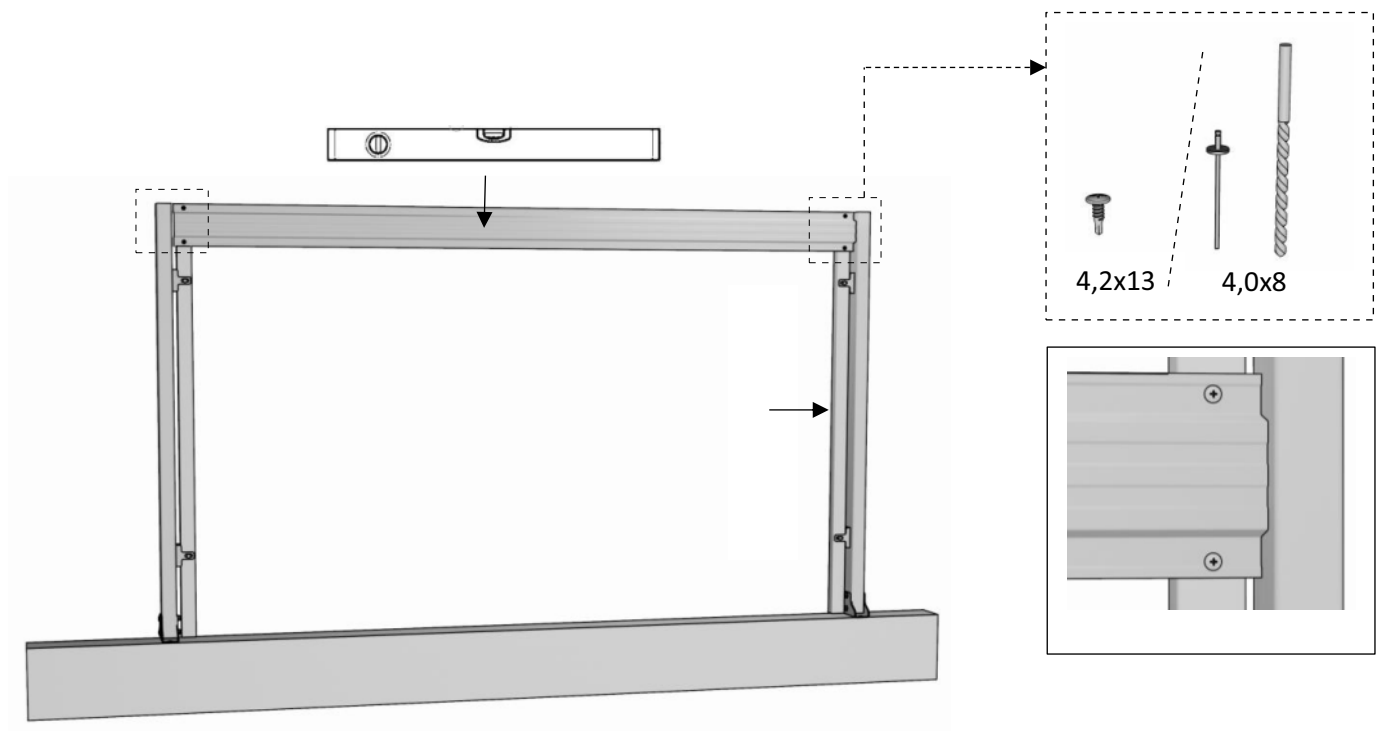

5

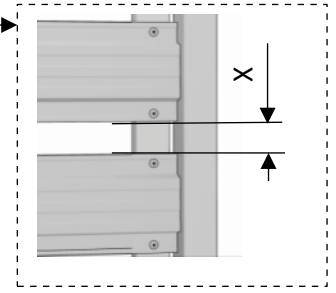
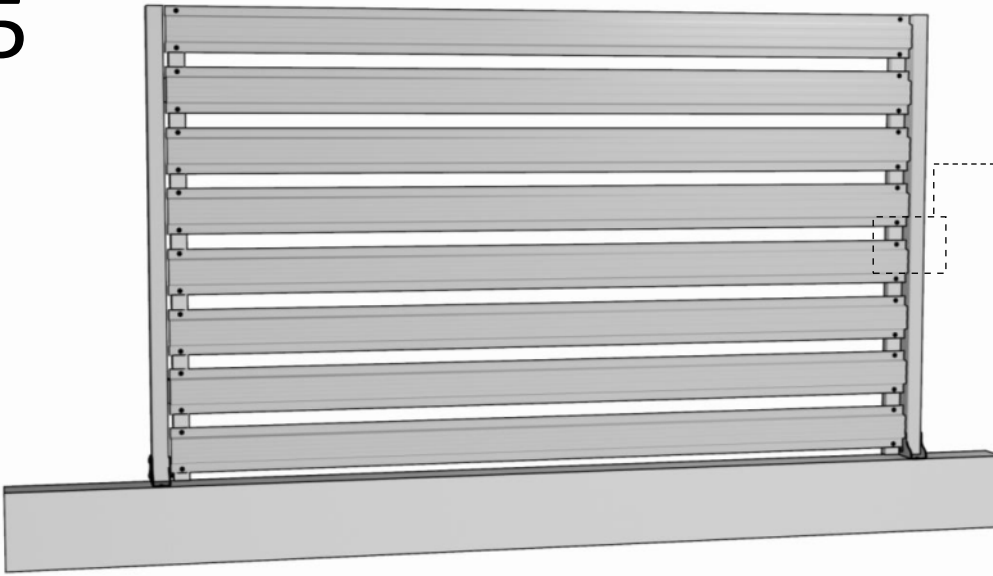

$X_{UN-02} = 35 \text{ mm}$

		01	02
Sicuro	SI	52	35
Forte	FO	49	
Spazio	SP	52	35
Unico	UN	52	35

		01	02	03	04	05	06	07	08
Sicuro	SI	52	35	52	35	7	52	52	52
Forte	FO	49		49		40	49	49	49
Spazio	SP	52	35	52	35	7	52	52	52
Unico	UN	52	35	52	35	7	52	52	52

6

